

Cahier d'exercices

de: _____



SOMMAIRE



A, a, α

page 3



E, e, e

page 8



I, i, i

page 13



Y, y, y

page 18



O, o, o

page 20



U, u, u

page 25



L, l, l

page 31



M, m, m

page 41



R, r, r

page 53



É, é, é

page 65



P, p, p

page 74

Consignes du cahier



Ecris

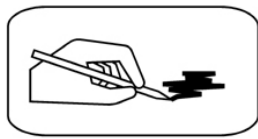

Colorie



Entoure



Coche

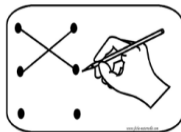

Relie

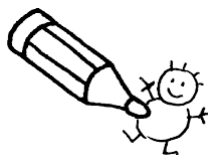

Dessine



A

a

A

a

a

a



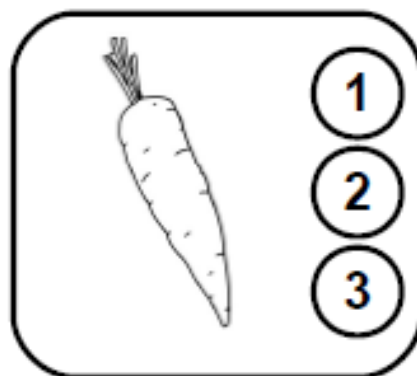
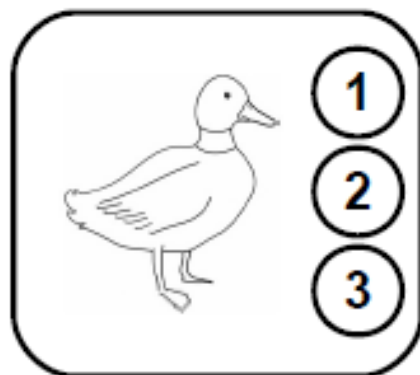
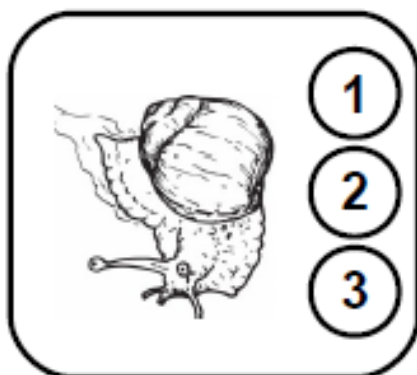
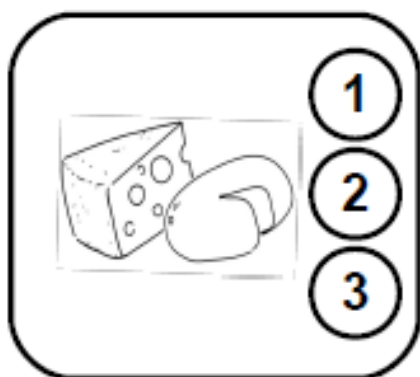
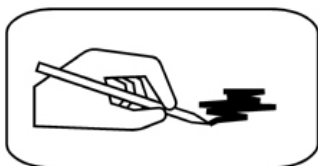

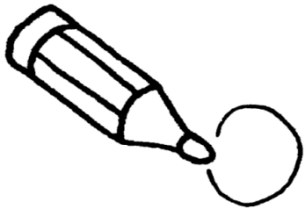

A, a, a



A e i a a o

O l a A U a

A o i a e E

AMI

malin

loua

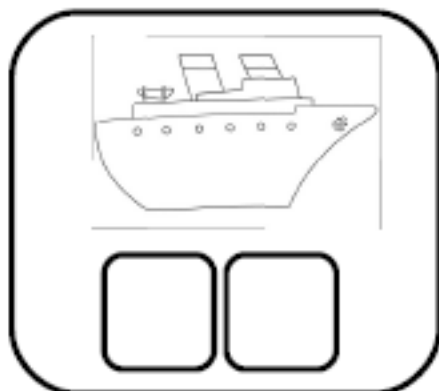
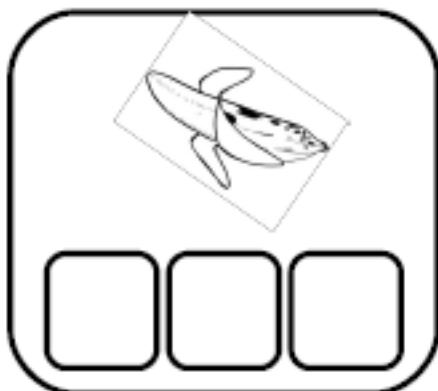
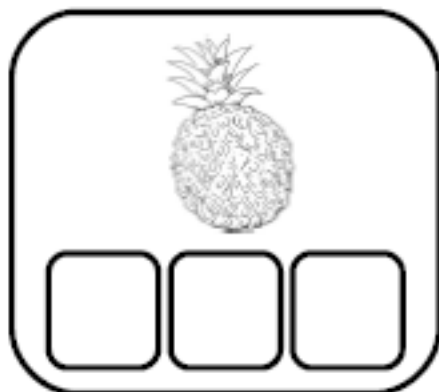

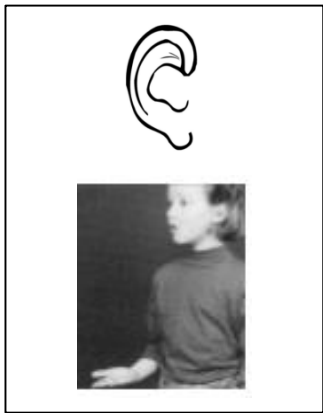

E

e

E

e

e

e

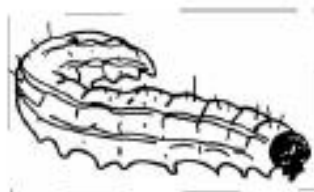
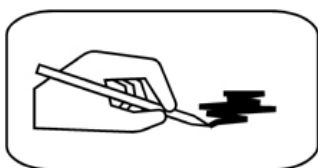

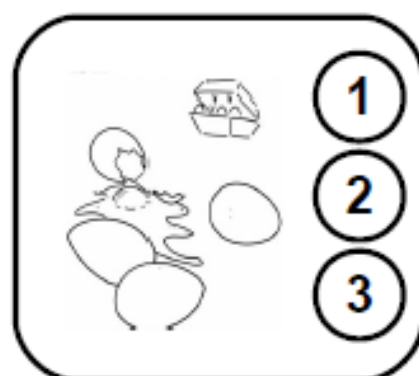
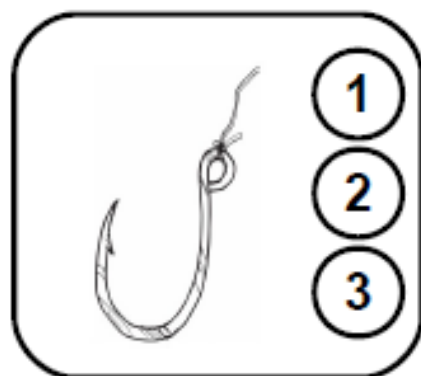
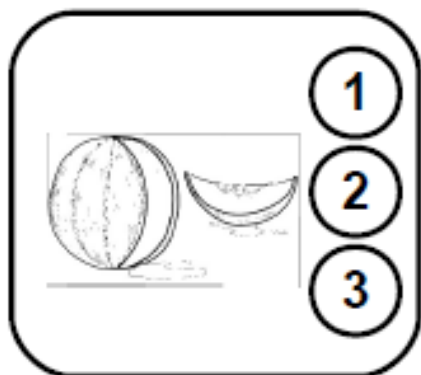
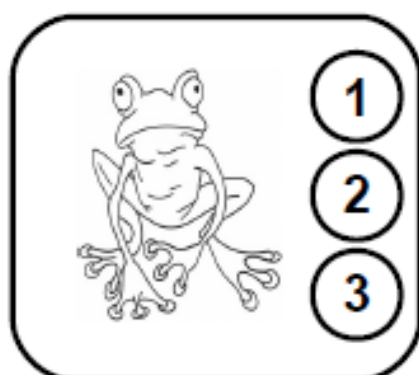
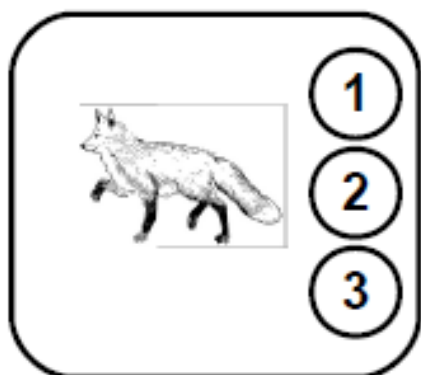
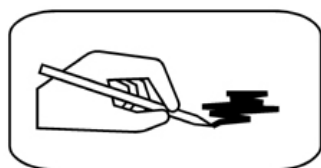

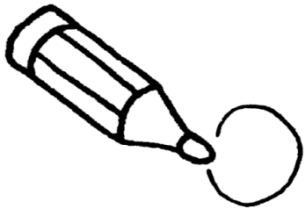

E, e, e



A e E a a o

O e a e U a

A o i a e E

CHEZ

terre

enfant

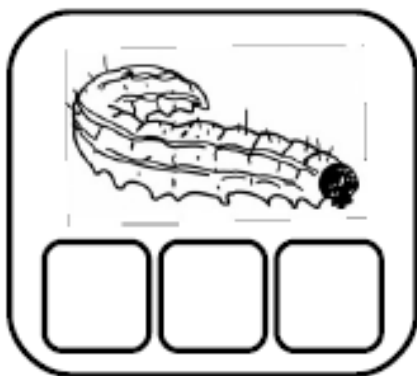
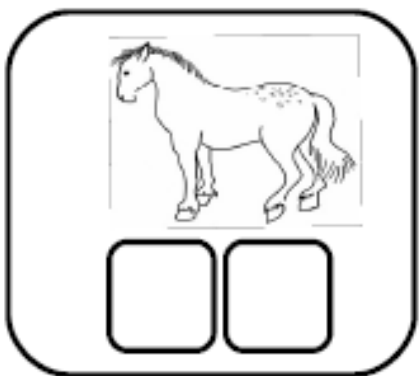
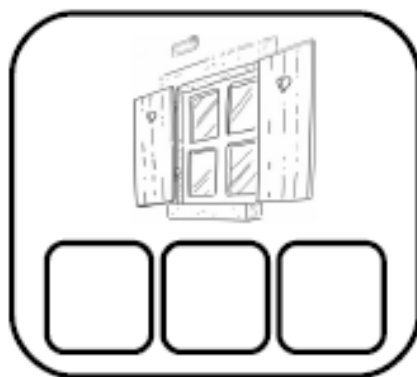
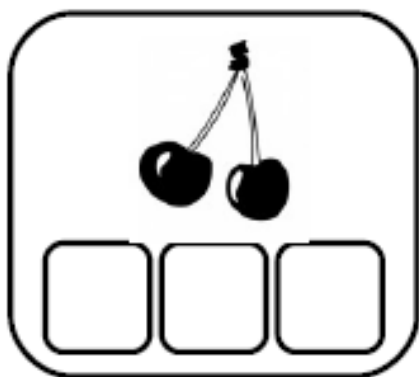
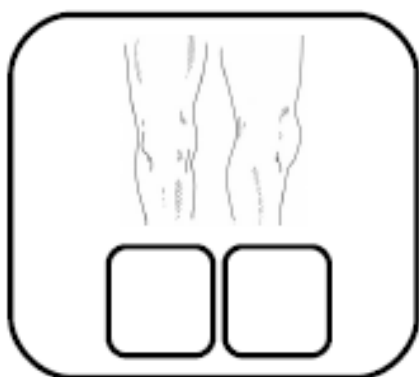



A large dashed rectangular box containing four sets of horizontal lines for handwriting practice. The first set has a solid vertical bar 'l' on the left. The second set has a solid lowercase letter 'i' on the left. The third and fourth sets have a lowercase letter 'i' on the left.

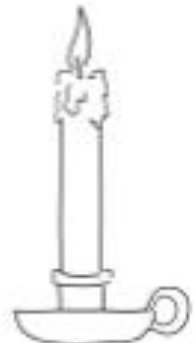
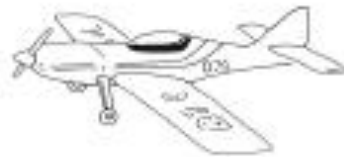
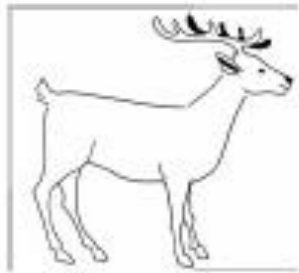
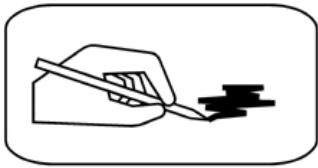

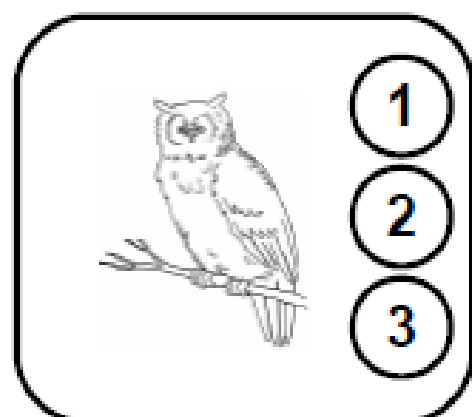
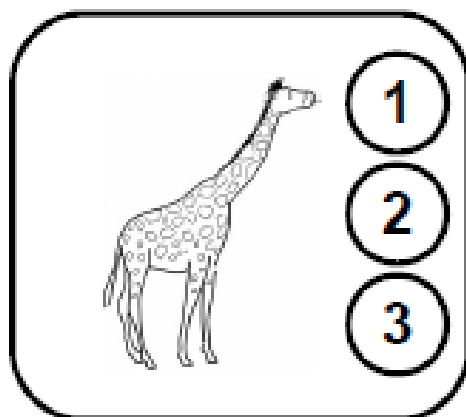
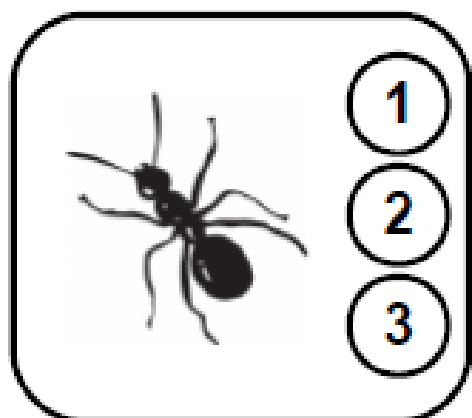
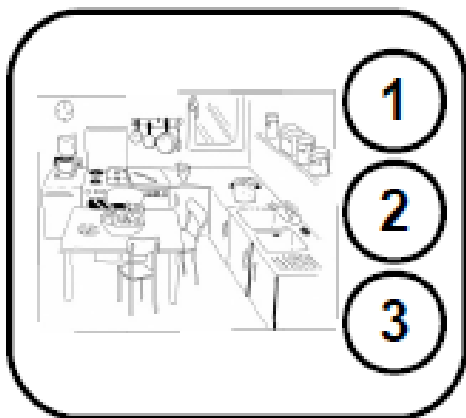
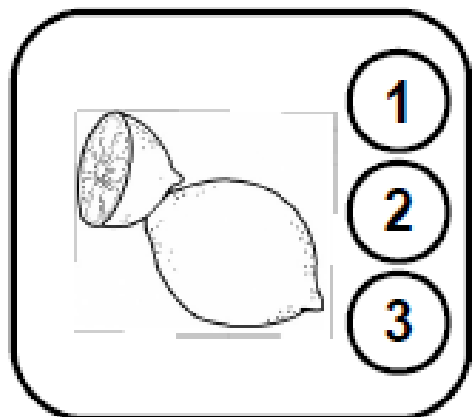
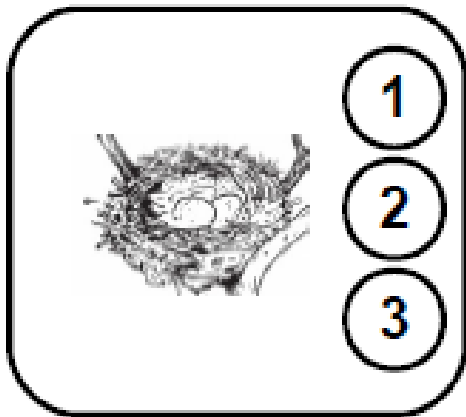
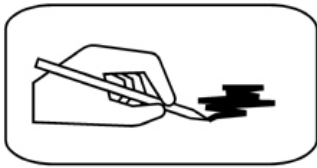

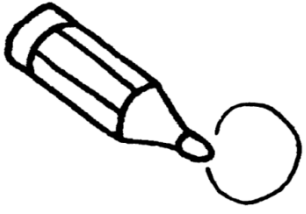

l, i, ï



l e i a ï o

O ï a i U i

A l i a e E

LOUIS

ami

parmi

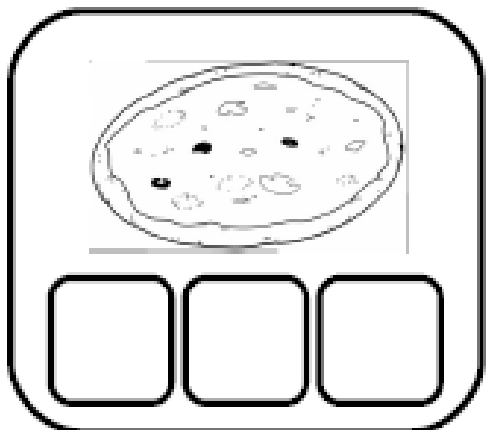
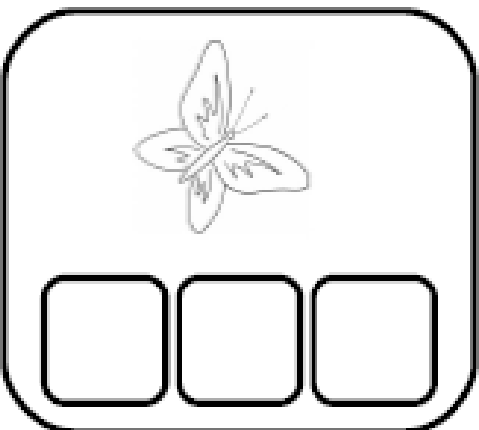
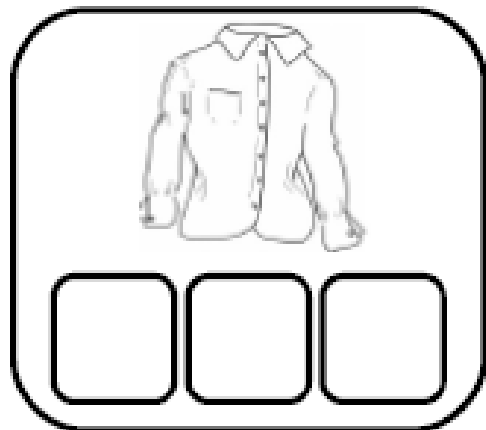
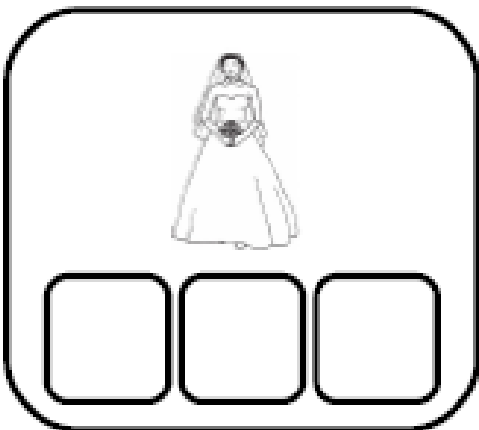
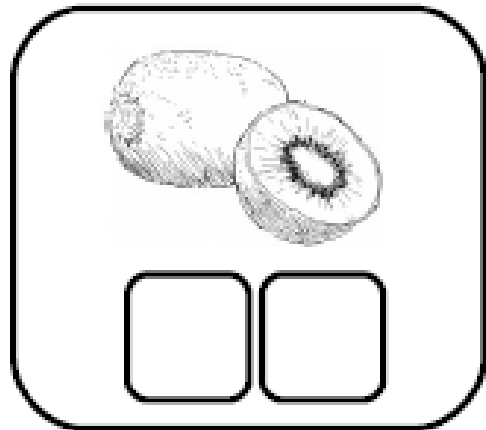
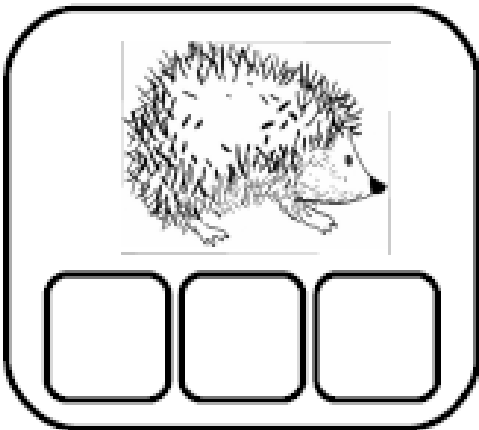

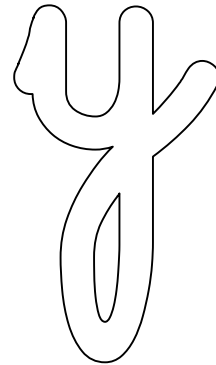
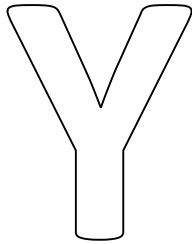
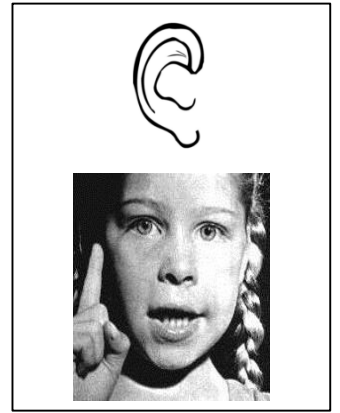

Y

y

y

y

A large rectangular area enclosed by a dashed border, containing four sets of horizontal writing lines. Each set consists of a top line, a middle line, and a bottom line. The letter 'Y' is written on the first set, and the letter 'y' is written on the second, third, and fourth sets.

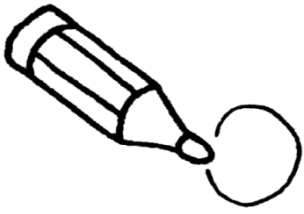

Y, y, y



Y e i y y o

y i a Y U i

A l i y e E

MYGALE

cygne

pyjama

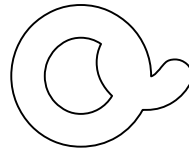
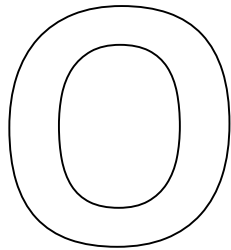
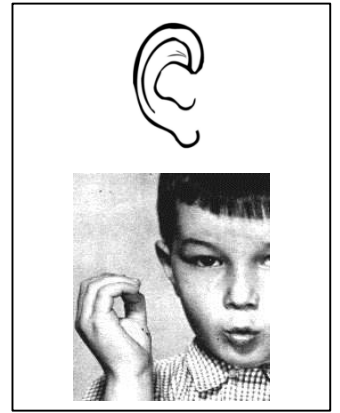

A large rectangular area enclosed by a dashed border, containing four sets of horizontal writing lines. Each set consists of a top line, a middle line, and a bottom line. The first set has a large, bold uppercase 'O' at the beginning. The second set has a large, bold lowercase 'o' at the beginning. The third and fourth sets have a small lowercase 'o' at the beginning.

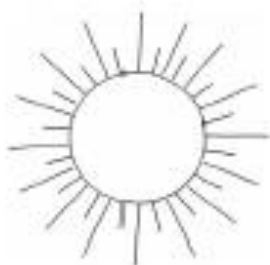
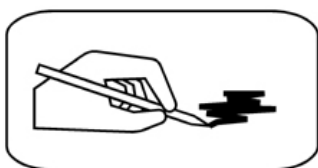

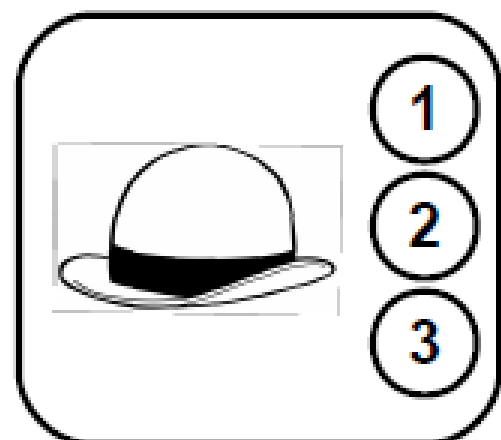
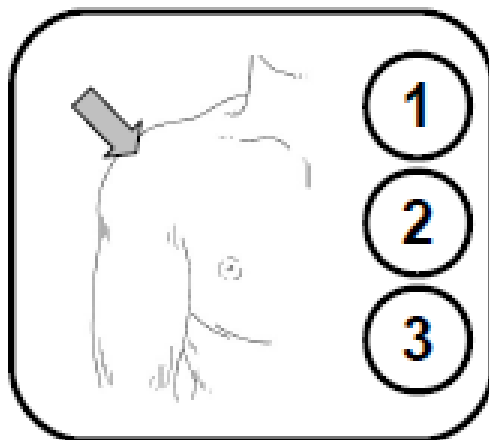
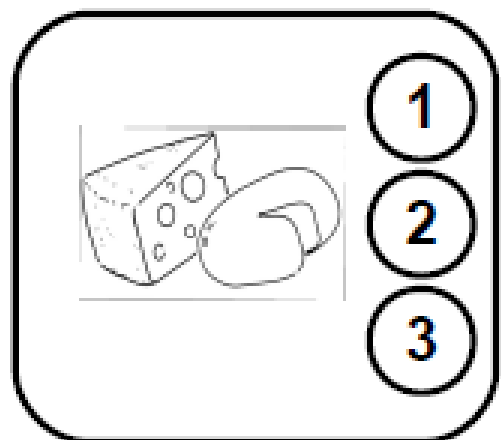
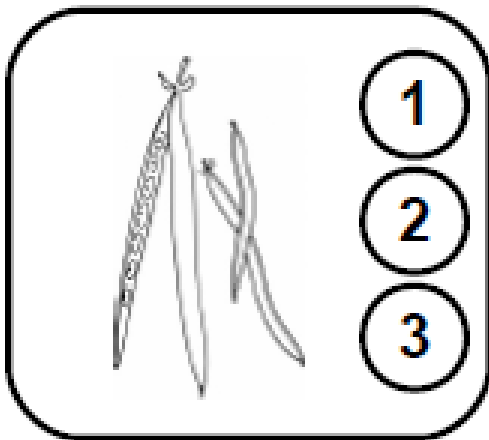
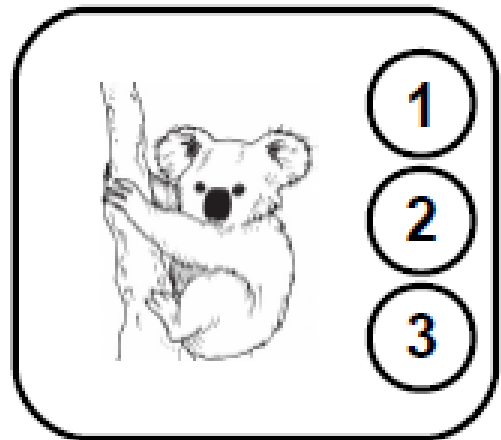
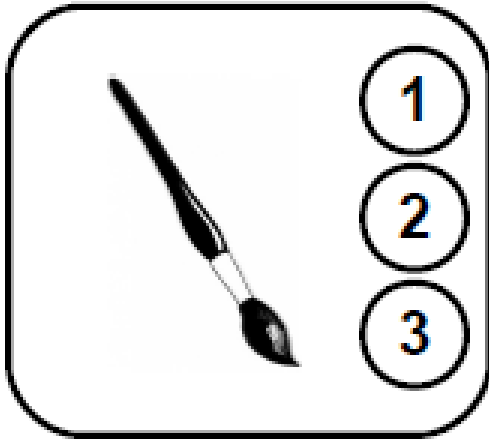
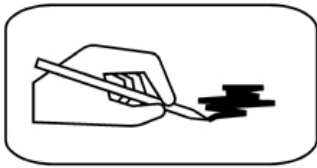

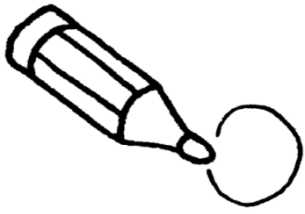

O, o, o



Y o i O y a

y o O Y e u

o l i o e E

DOMINO

dodo

Dory

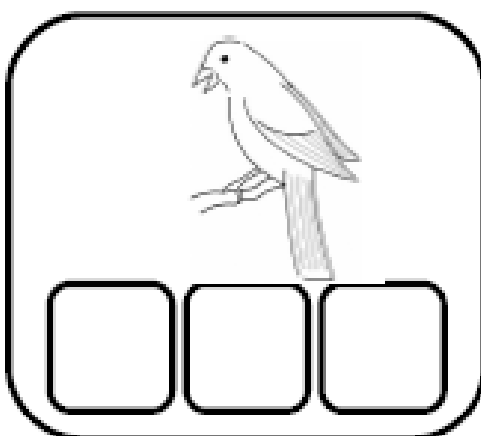
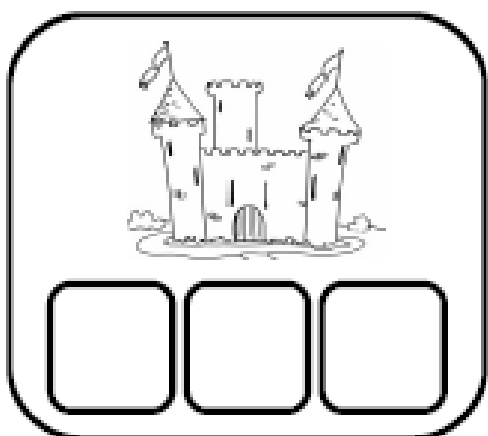
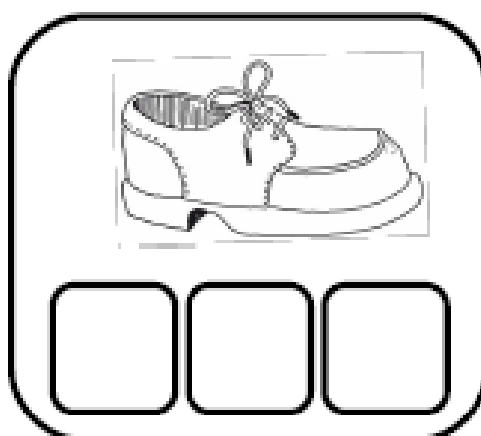
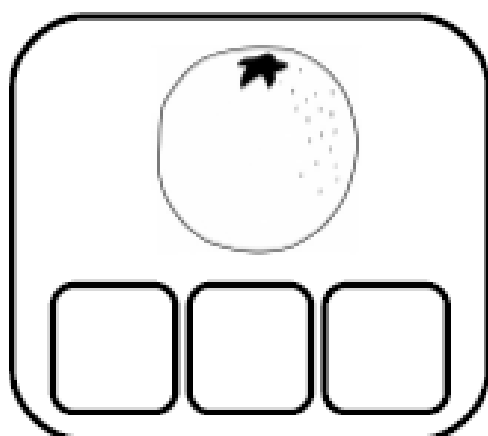
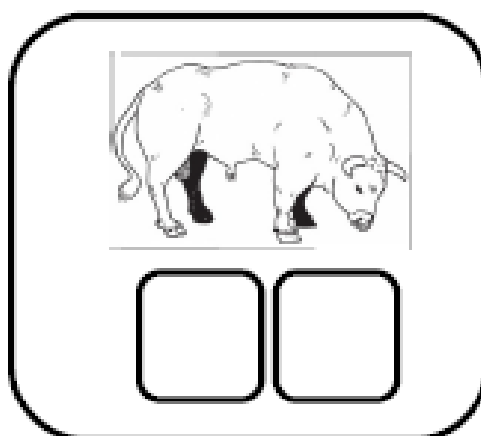

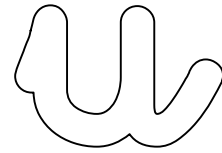
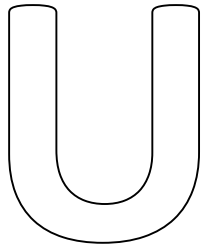
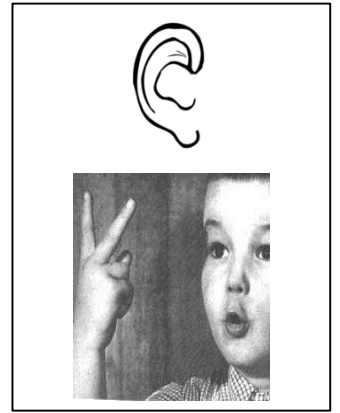

Handwriting practice area with four rows of lines. The first row contains a large uppercase 'U'. The second row contains a large lowercase 'u'. The third and fourth rows contain smaller lowercase 'u's for tracing.

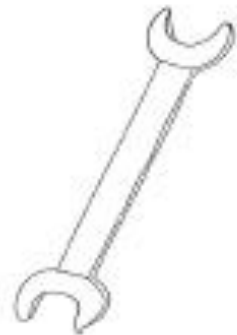
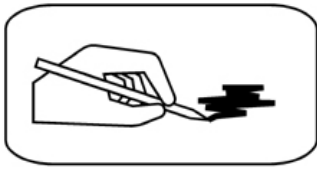

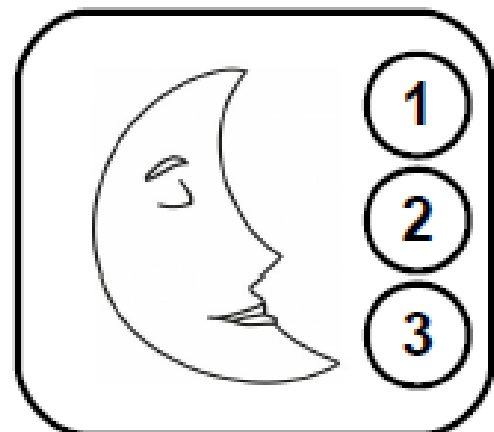
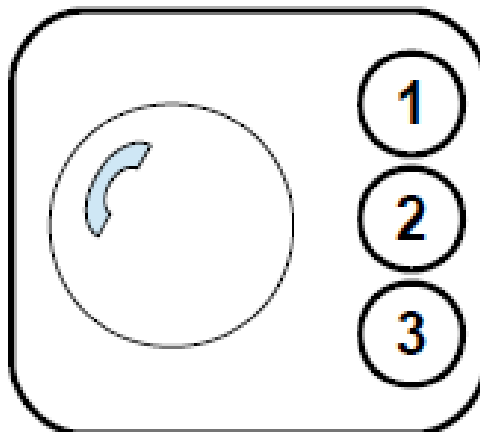
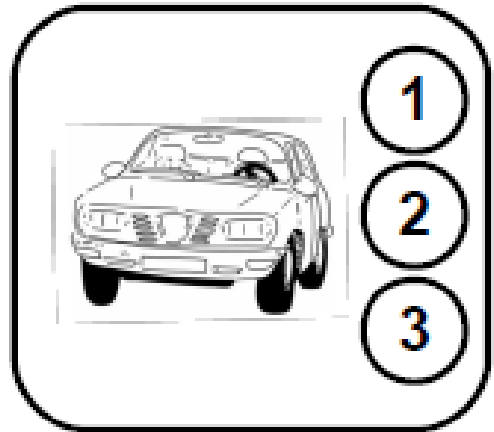
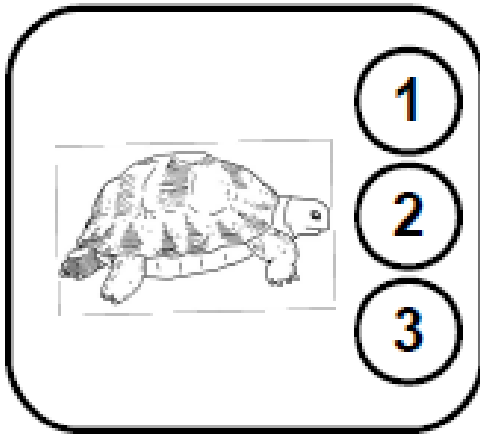
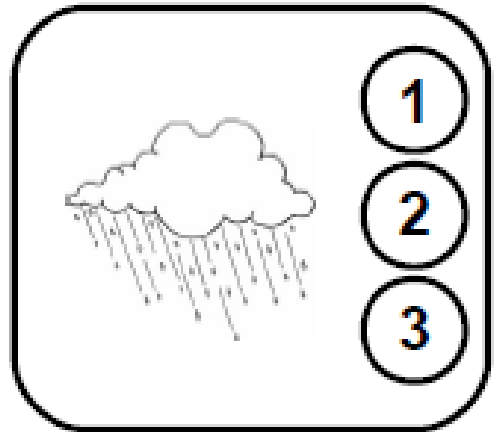
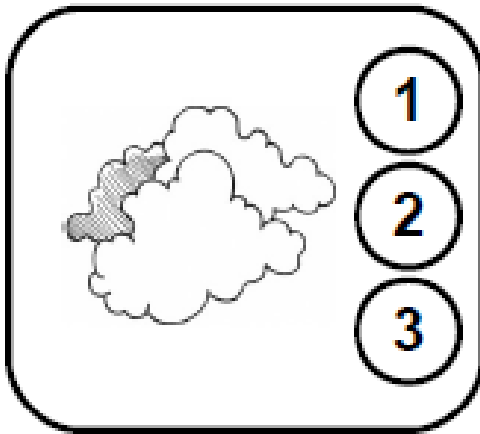
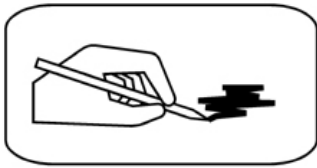

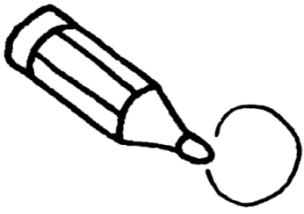

U, u, u

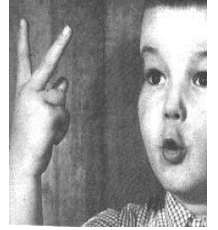

Y u i U y i
a u O A e u
o U i u e E

BULLE rue pull

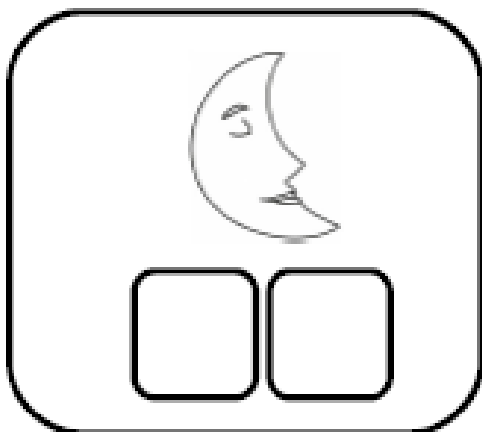
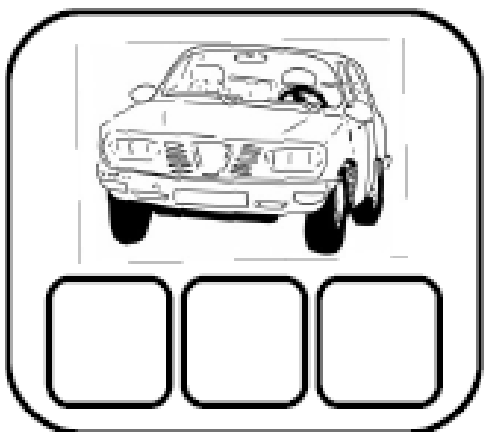
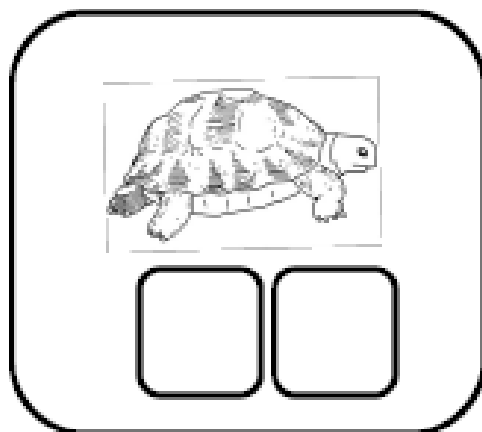
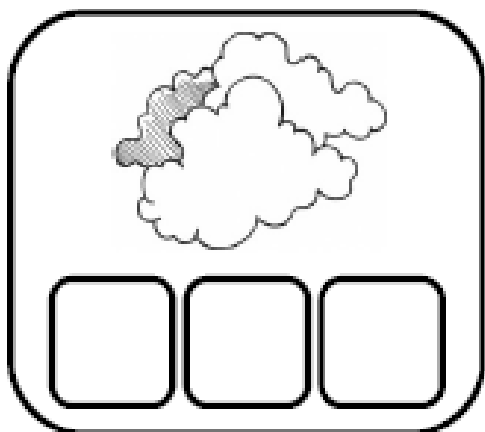
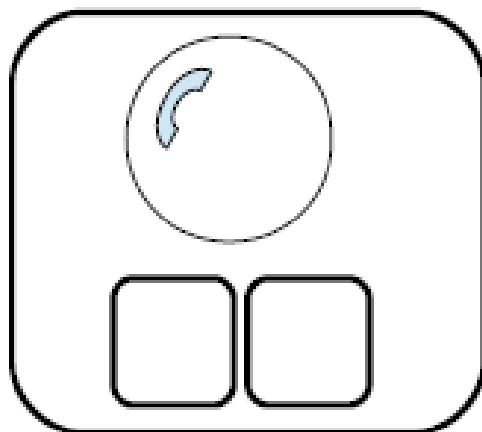
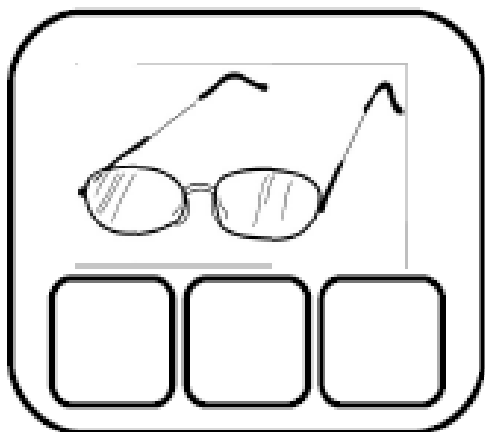



a



i



o



u



unerange



unrosoir



un p.....ll

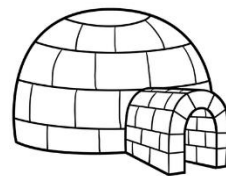

ungloo

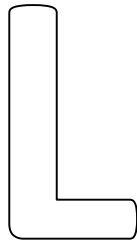
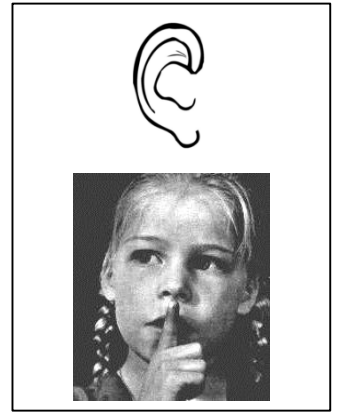

Handwriting practice area with a dashed border and four horizontal lines. The first line contains a solid uppercase 'L'. The second line contains a solid lowercase 'l'. The third and fourth lines are empty for practice.

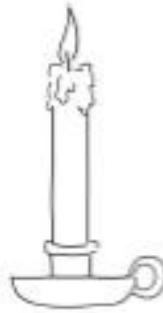
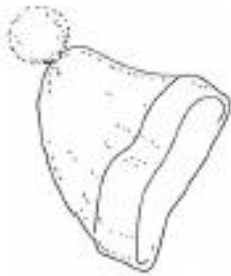
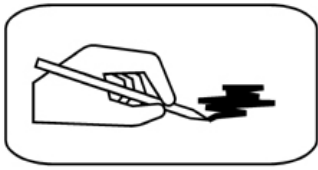

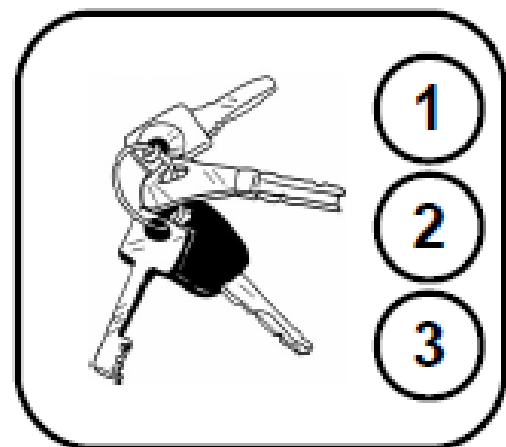
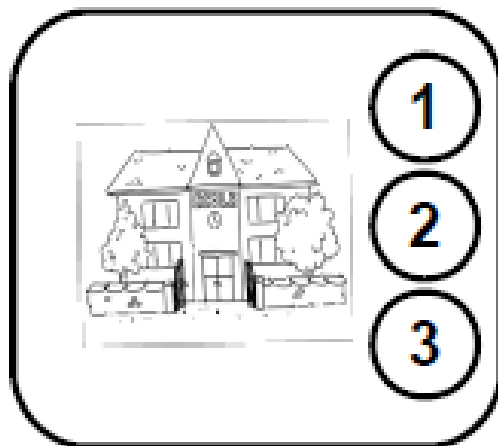
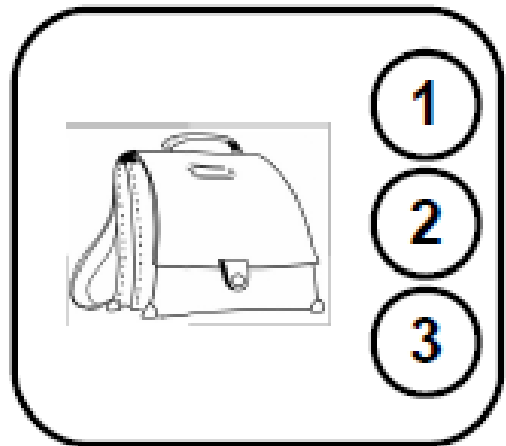
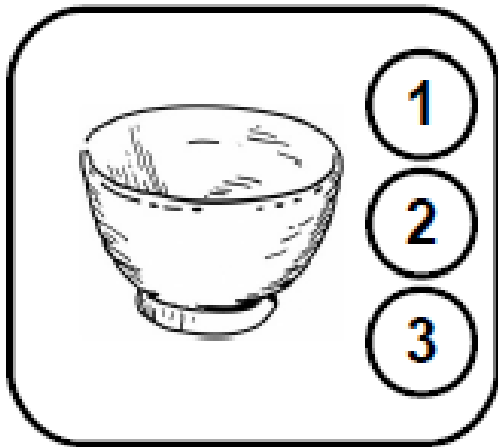
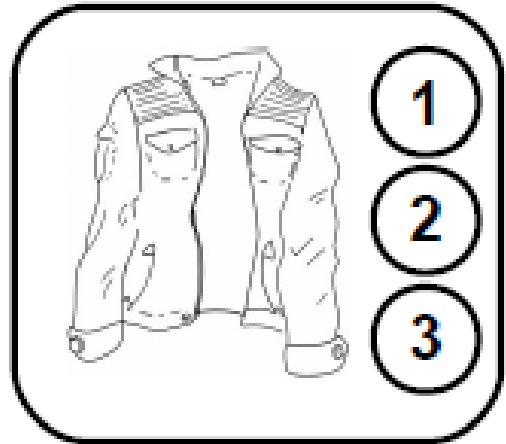
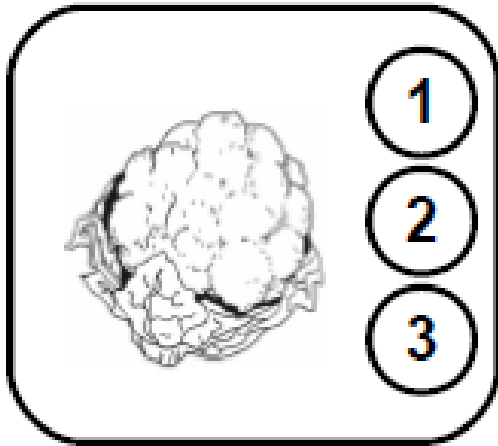
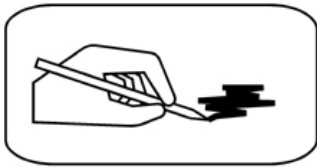

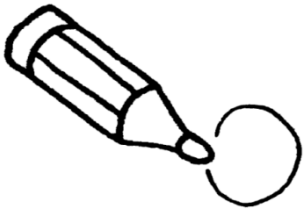

L, l, l



l u L U l i
l l O A L u
o L i l e E

LAPIN râler journal

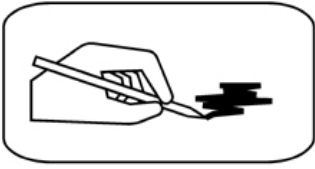

L, l, l



LA

li

le

LE

lu

lo

LI

la

ly

LO

ly

lu

LU

le

la

LY

lo

li

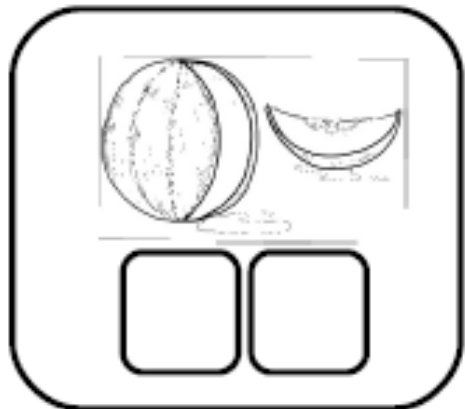
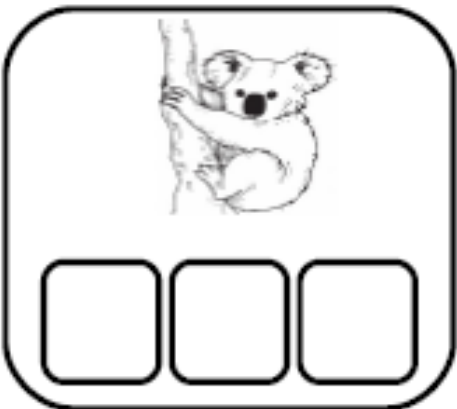
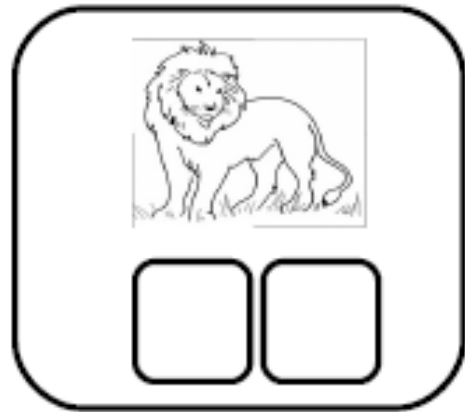
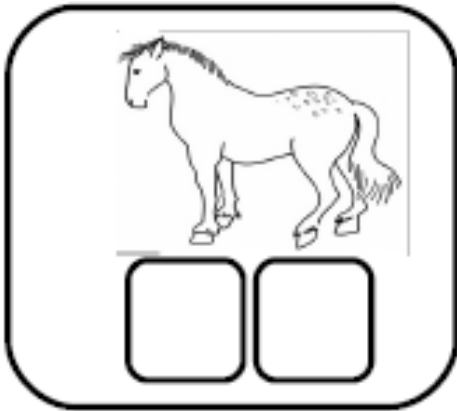

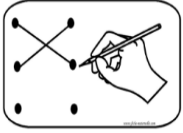

•

•

la



•

•

li



•

•

lu



•

•

lo













•

•

le





la



le



li



lo



lu



un vé.....



unpin



unvre



une pou.....



desnettes

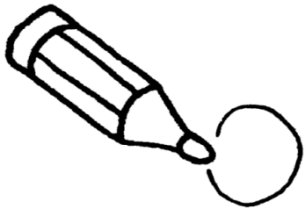

Le lit.

Il lit.

Le lilas.

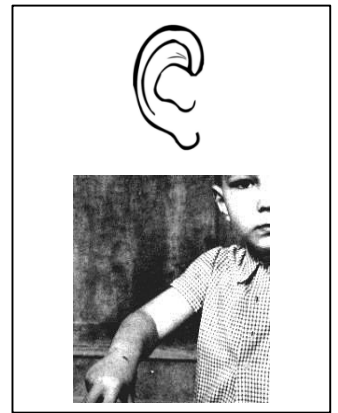

M

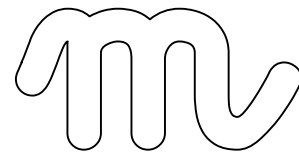

M

m

m

m

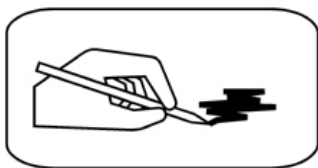

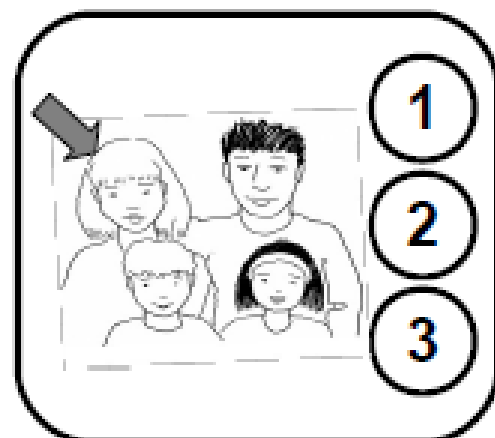
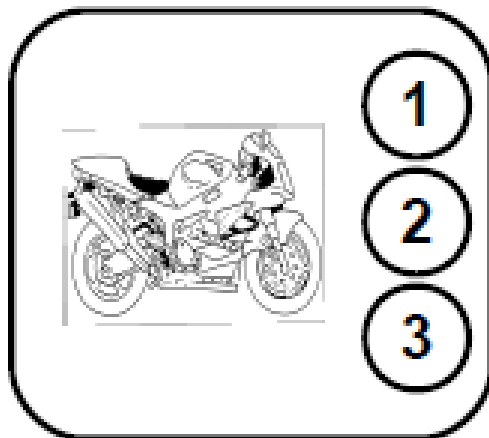
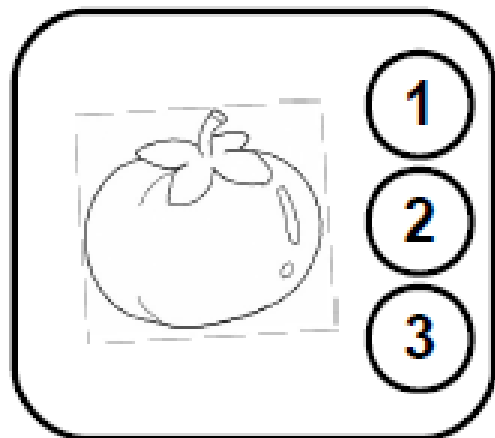
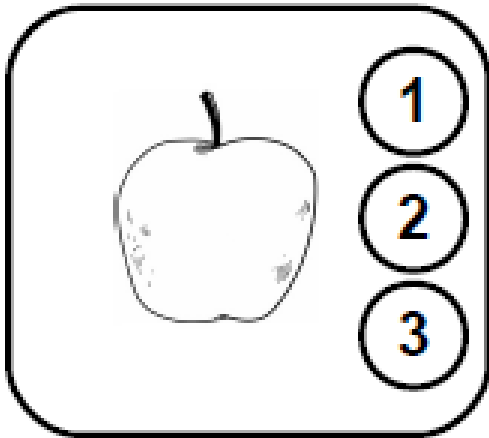
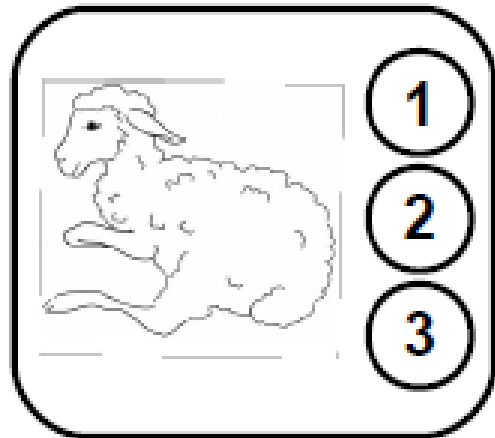
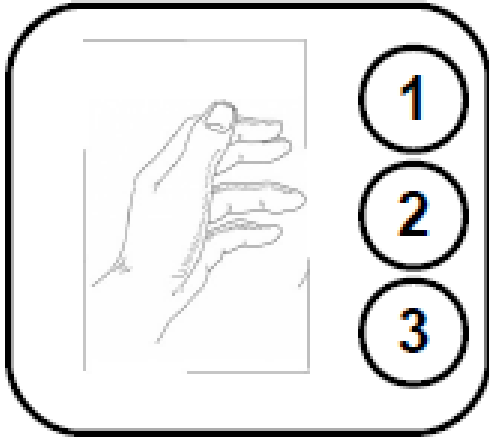
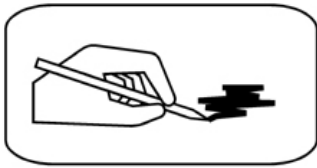

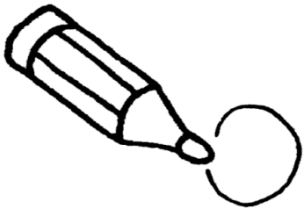

M, m, m



m u M U l i
m l O A m u
o M i m e E

CARAMEL maman mille

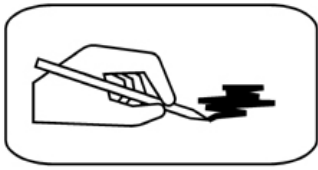

M, m, m



MI

me

ma

MO

my

mu

MA

mo

my

MY

ma

mi

ME

mi

mo

MU

mu

me

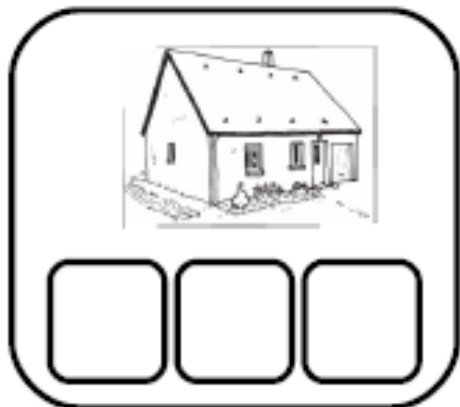
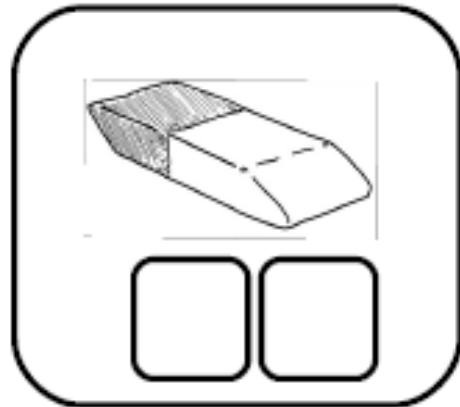
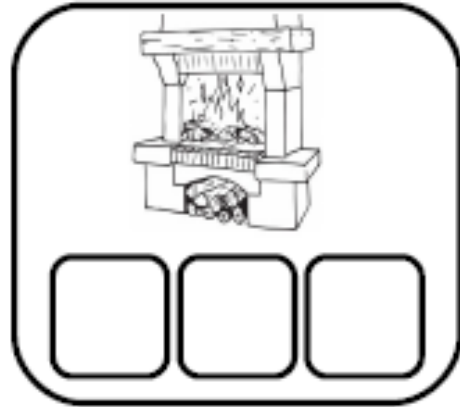
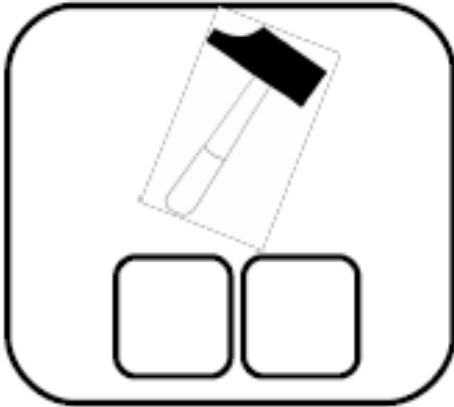

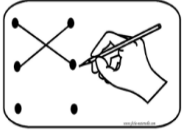

•

• me



•

• mu



•

• ma



•

• mo



•

• mi





ma



me



mi



mo



mu

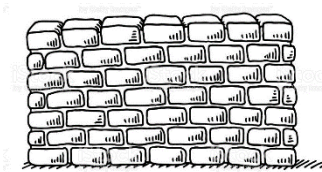

unr



uneman

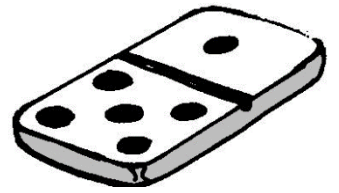

un do.....no





une da.....



uneto

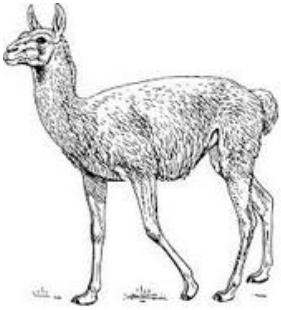

	<p>a - a - m - l</p> <p>un _____</p>
	<p>l - m - u - e</p> <p>une _____</p>
<p>1000</p>	<p>ll - m - i - e</p> <p>_____</p>

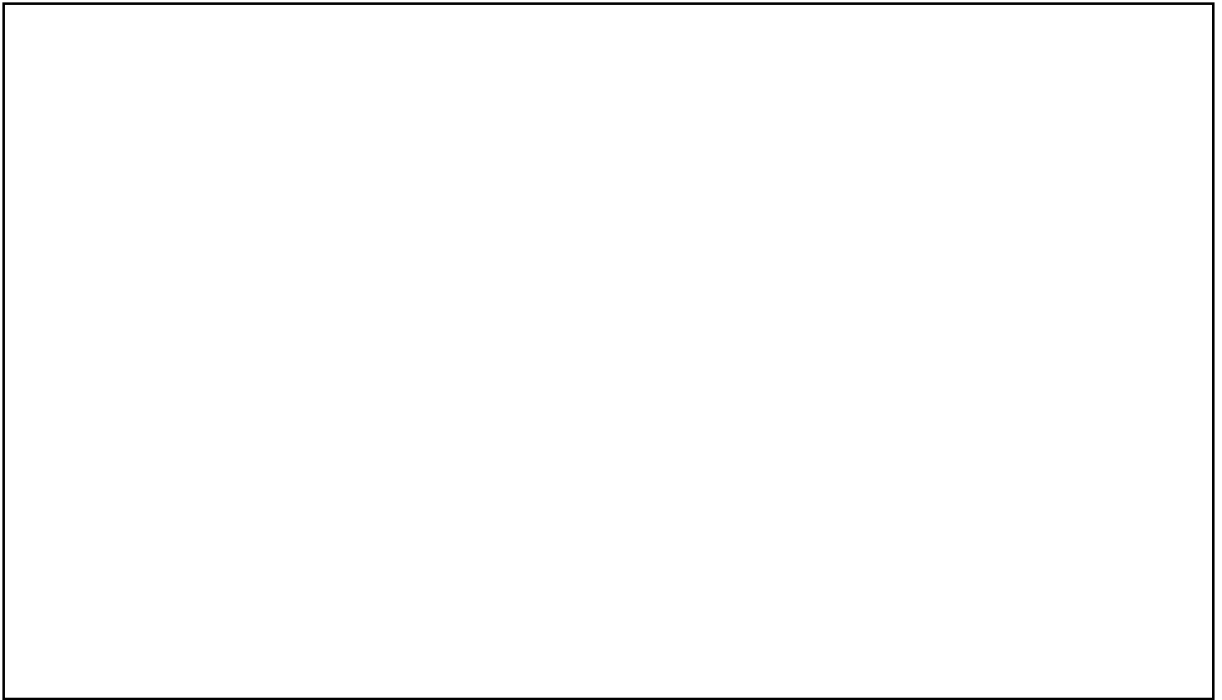
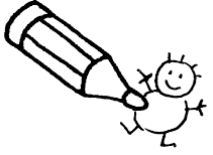

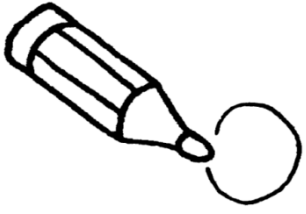

La mamie lit.
Il a la lame.



La mule a mal.
Il a mal.

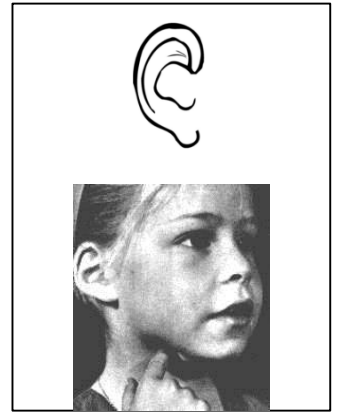

R

r

R

r

r

r

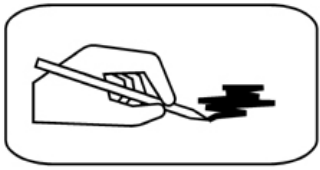

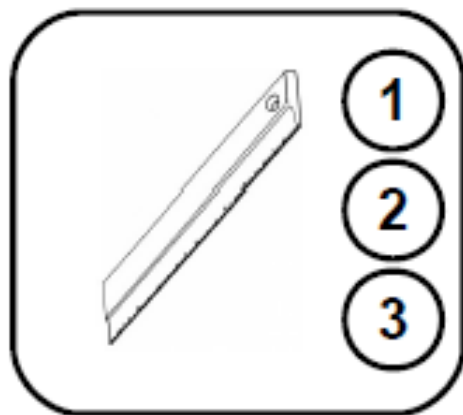
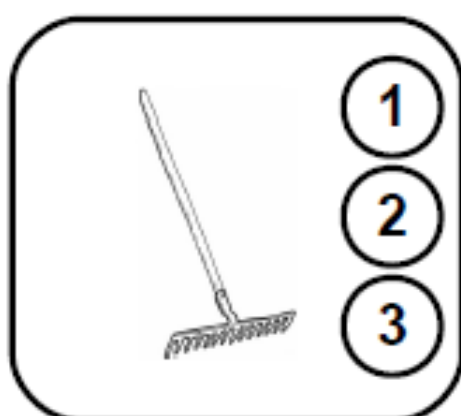
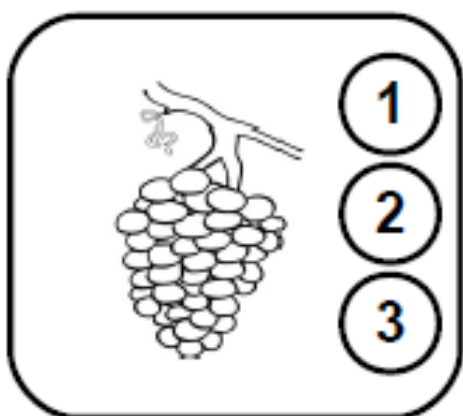
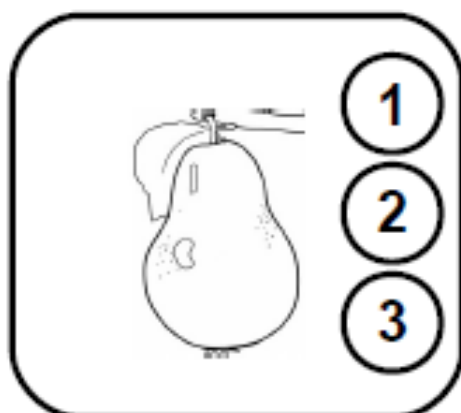
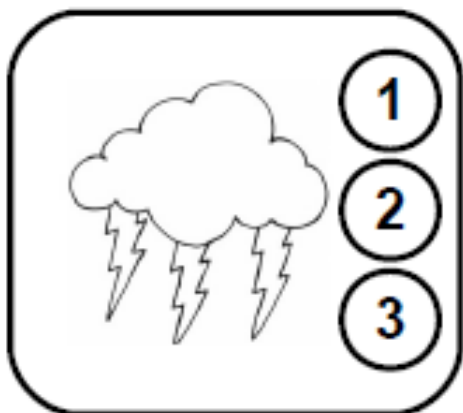
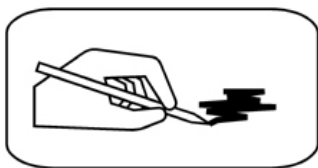

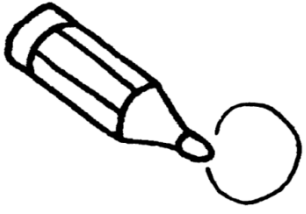

R, r, r



m u R r l r

m l r A R u

o r i r e L

ROUGE marier *courage*

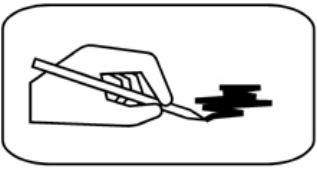

R, r, r



RA

ro

ro

RO

ra

ri

RE

ru

ry

RU

ry

ru

RI

re

re

RY

ri

ra

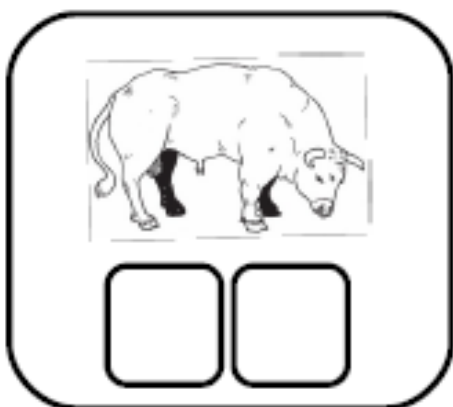
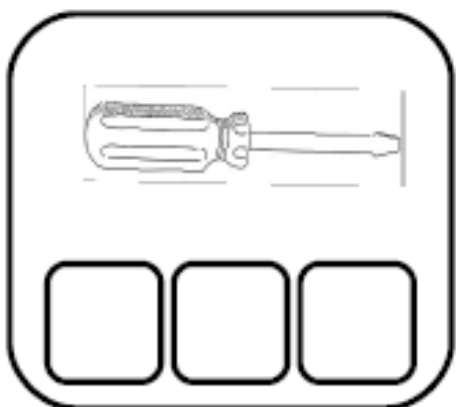
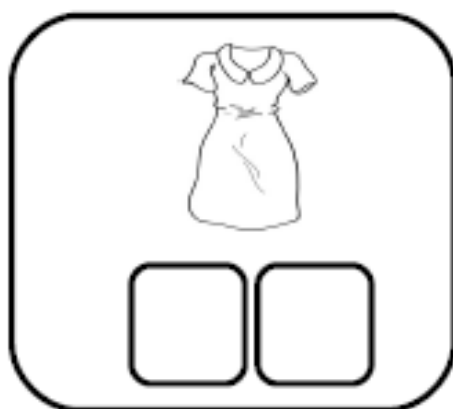
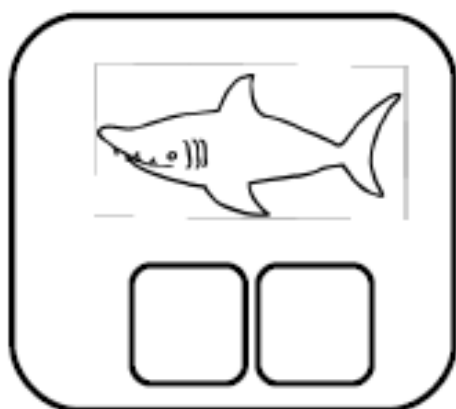

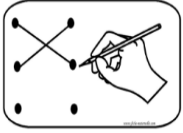

• re



• ra



• ru



• ri



• ro





ra



re



ri



ro



ru



duz

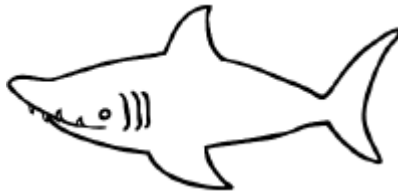

unquin



uneche

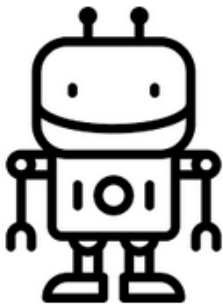



unbot



undis



	<p>r e i l</p> <hr/>
	<p>e m a - r</p> <p>une <hr/></p>
	<p>r r i e</p> <hr/>

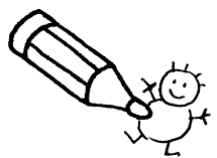

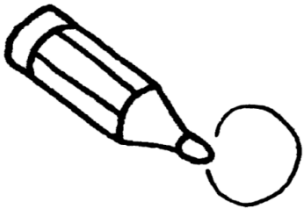

Il rit.
Marie rit.



Il a plu.
Il a mal.

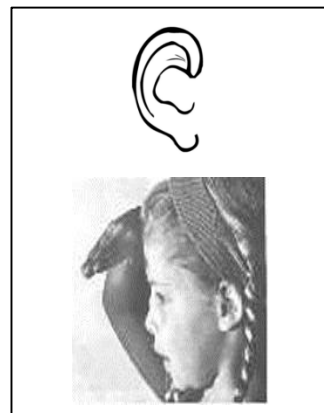

É

é

É

é

é

é

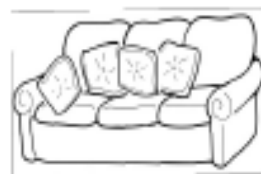
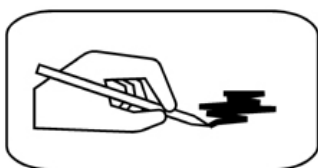

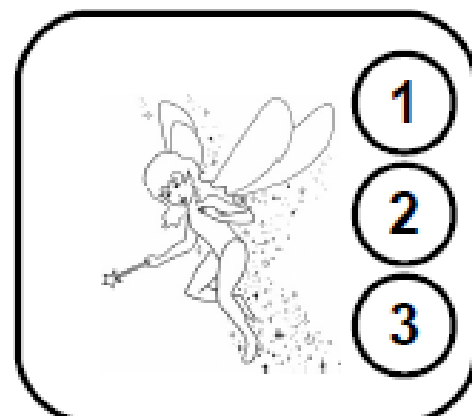
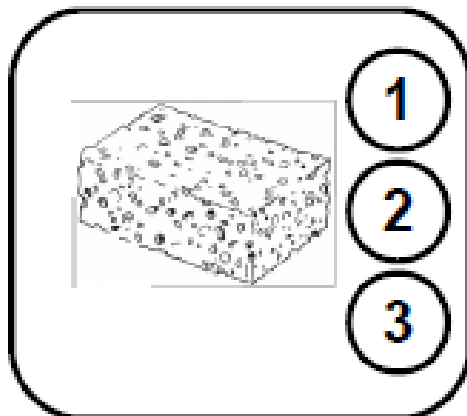
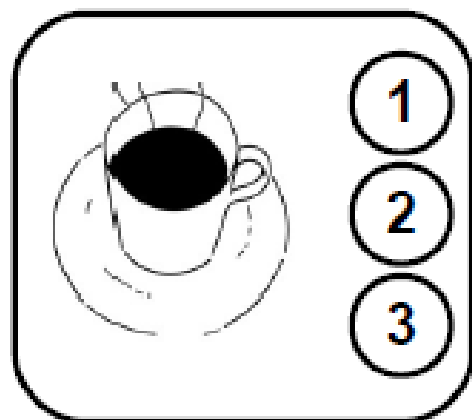
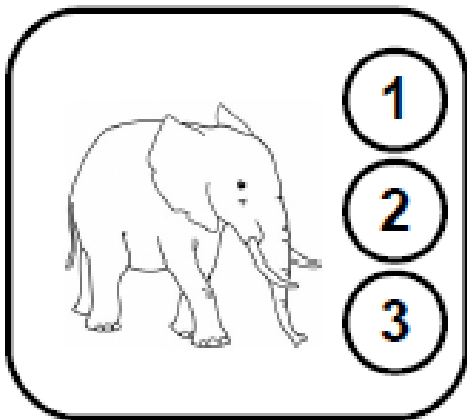
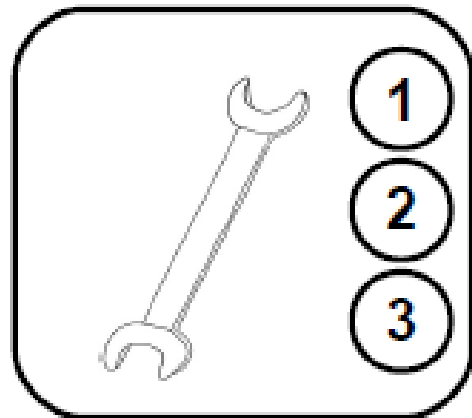
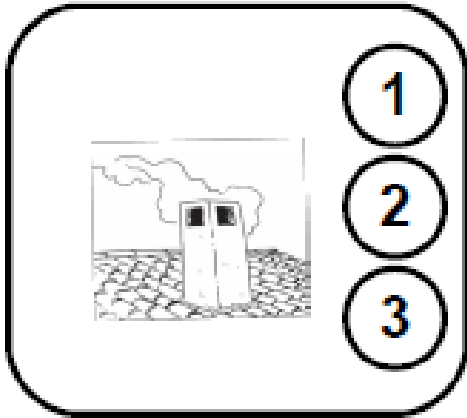
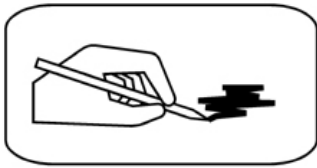

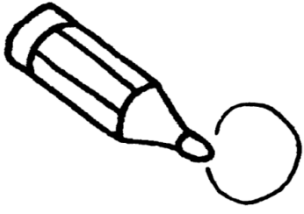

É, é, é



é è E e é è

É è e é E È

è E é è e E

ÉLÉPHANT

levé

lévrier

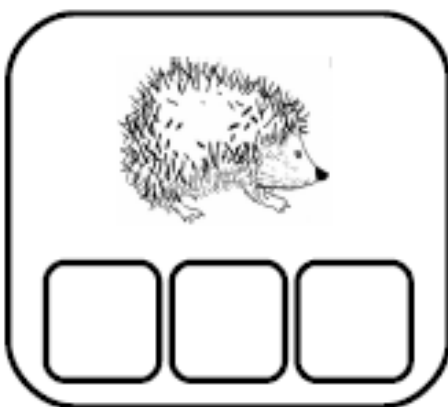
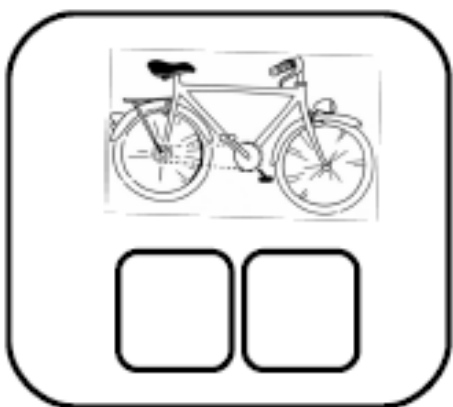
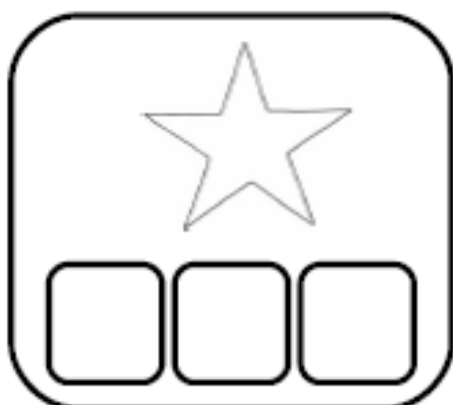
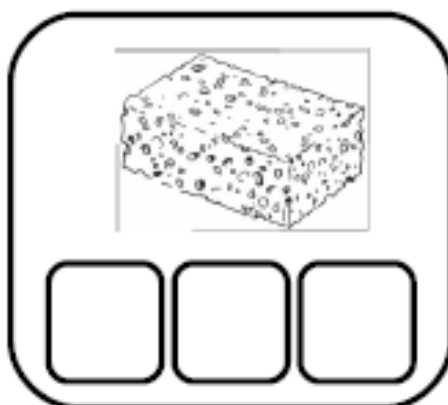
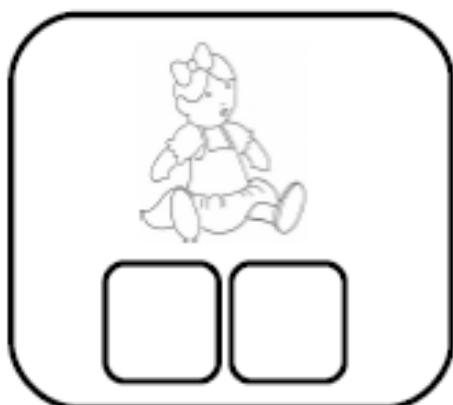



ré

mé

lé

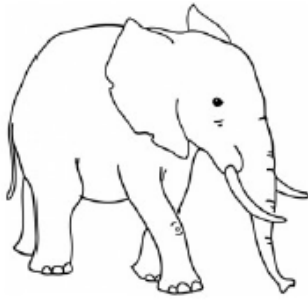

un é.....phant





unveil



une ca.....ra



	<p>b é é b</p> <p>un _____</p>
	<p>ée a ll</p> <p>une _____</p>

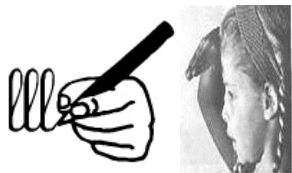
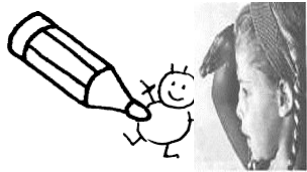

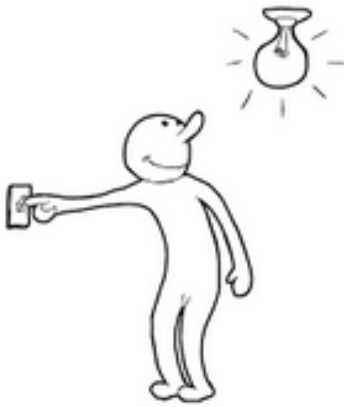
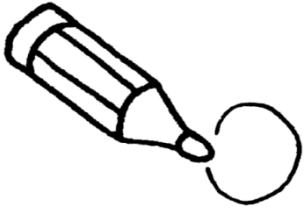

Il a allumé.

Il a relu.



Rémi a mal.

Rémi a lu.

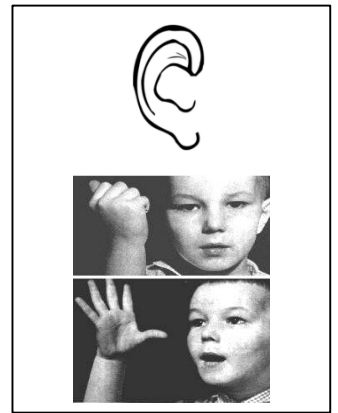

P

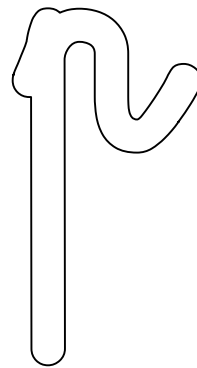

P

~

~

~

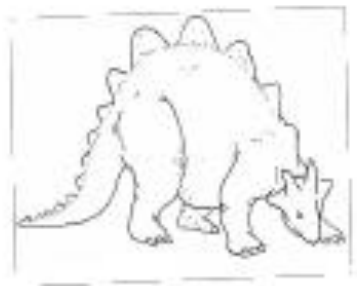
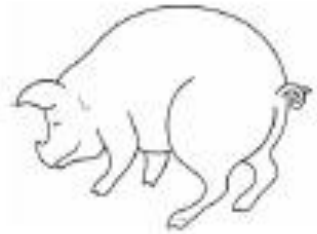
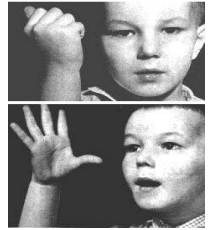
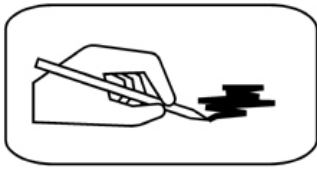

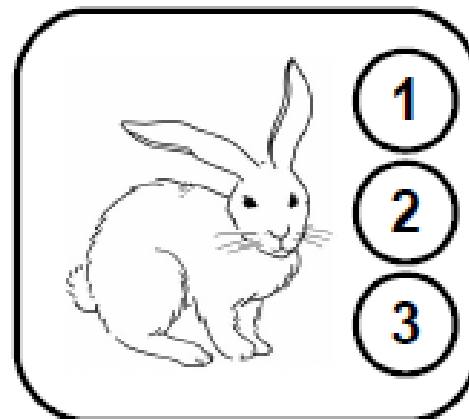
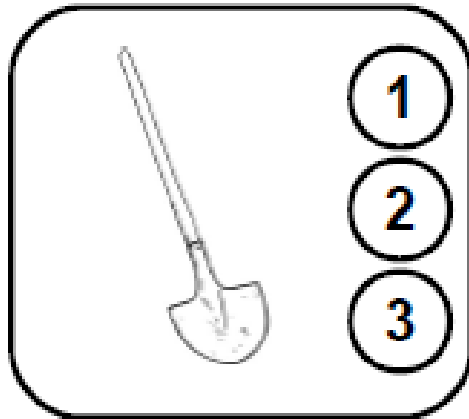
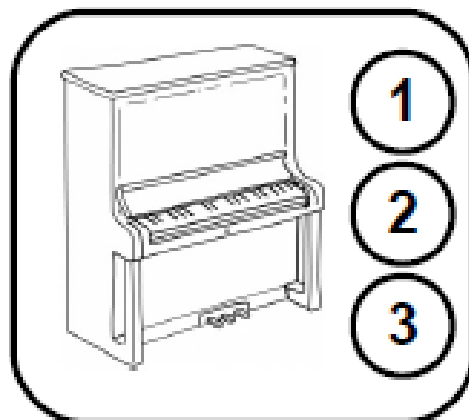
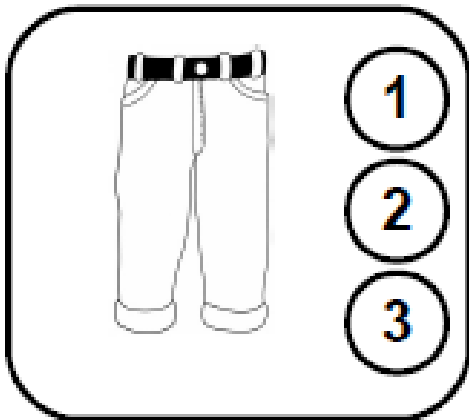
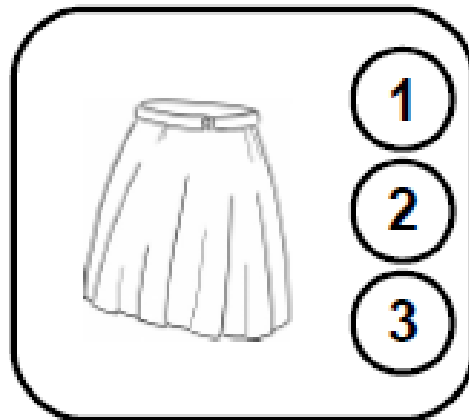
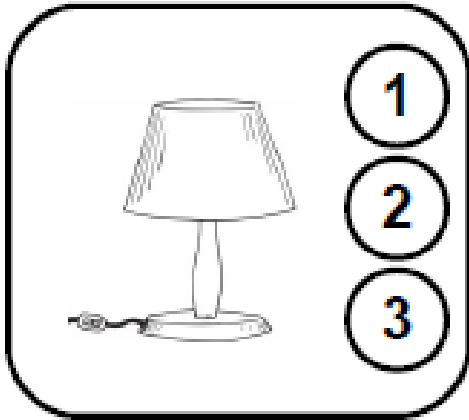
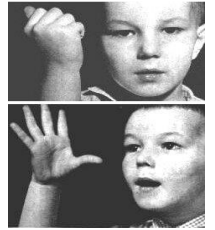
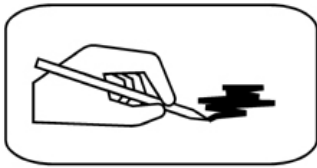

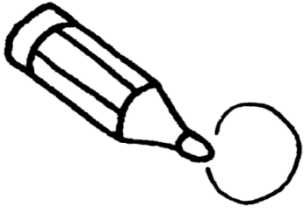

P, p, p

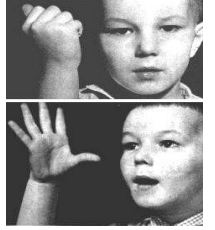

PAPA

POUR

APPEL

place

permis

repos

apporter

plume

parapluie

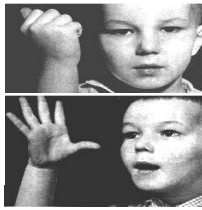
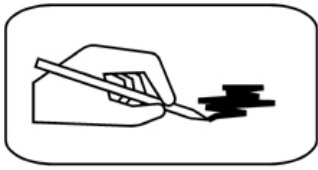

P, p, p

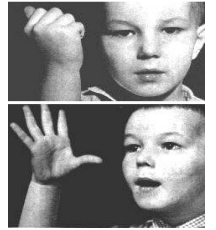

PU

pe

pa

PA

py

pu

PI

pa

pe

PE

po

py

PY

pu

po

PO

pi

pi

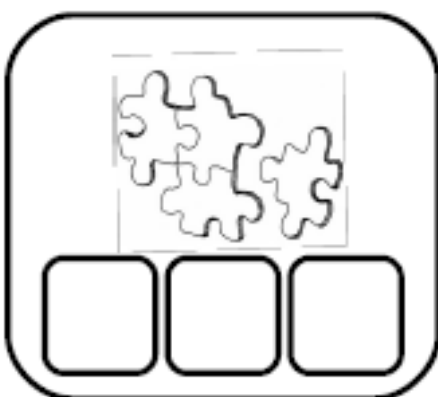
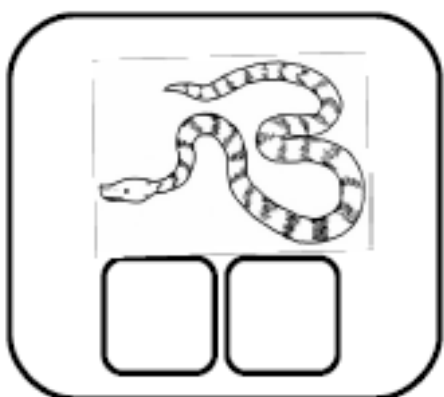
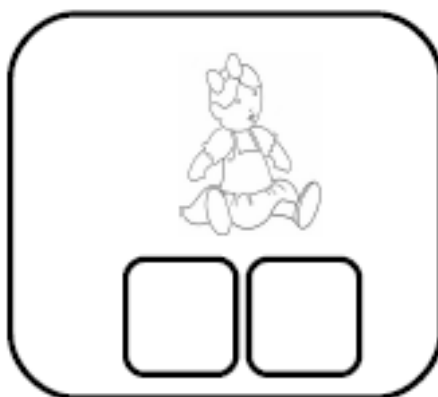
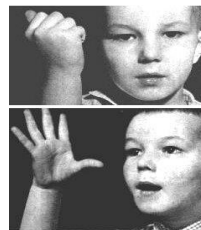

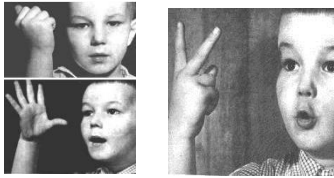
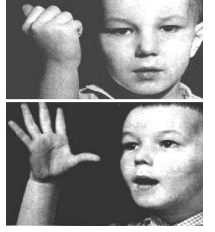
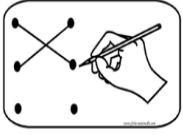

•

•

•

•

•

•

• p

• p

• p

• p

• p

• p

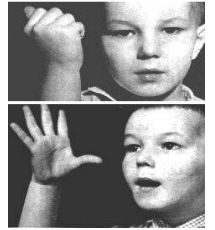

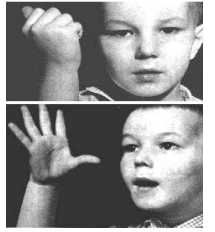

pa



pe



pi



po



pu

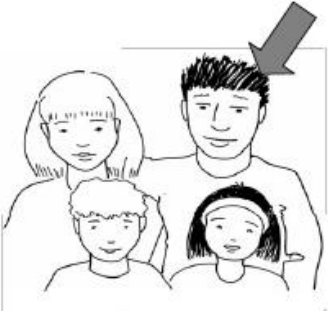

unpa

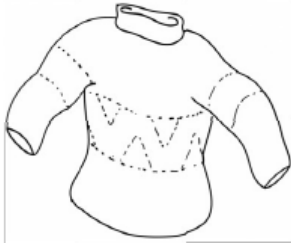

unll

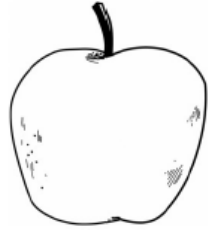

unemme



unrate



uneluce

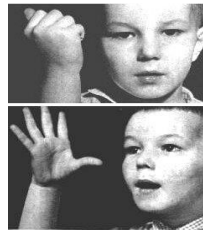
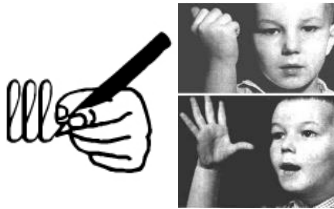

	<p>a a r r</p> <p>un _____</p>
	<p>r e i - r</p> <p>une _____</p>
	<p>u r ll</p> <p>un _____</p>

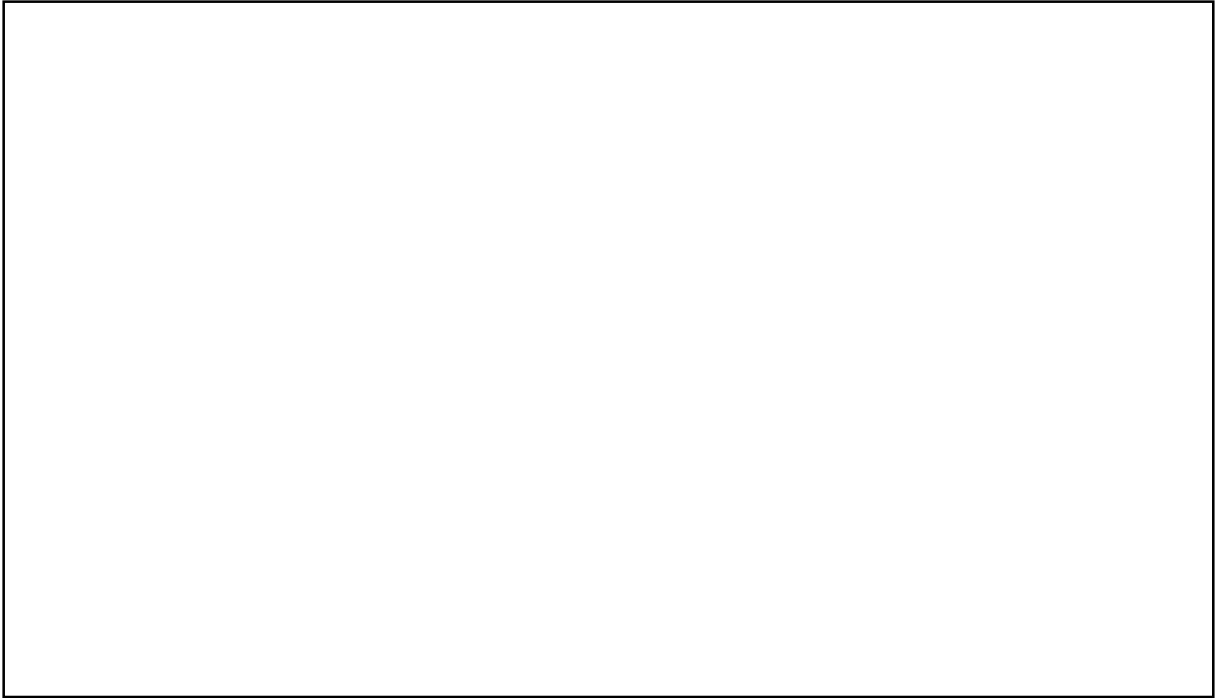
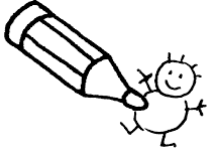
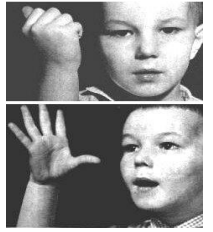

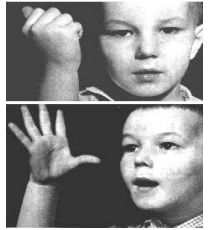
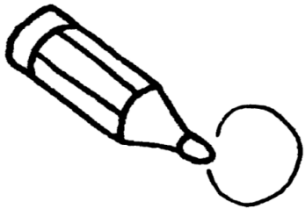

Il a pris la pomme.

Il a pris la lame.



Il a mis le pull.

Mamie a mis le pull.